

# Kuhinja "IN" VH 80/36

# Matis

N A M E Š T A J • www.matis.rs



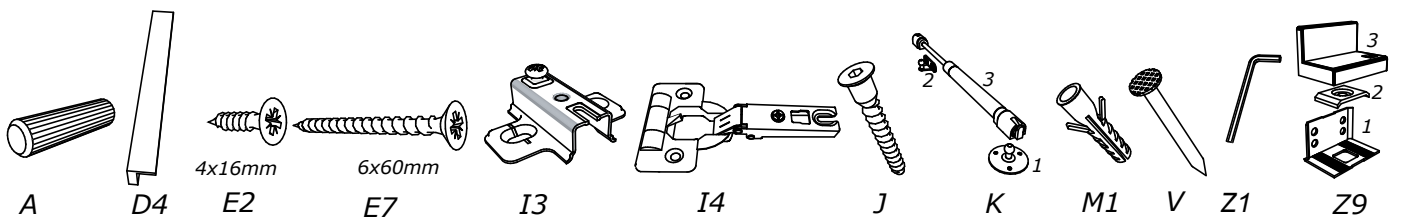
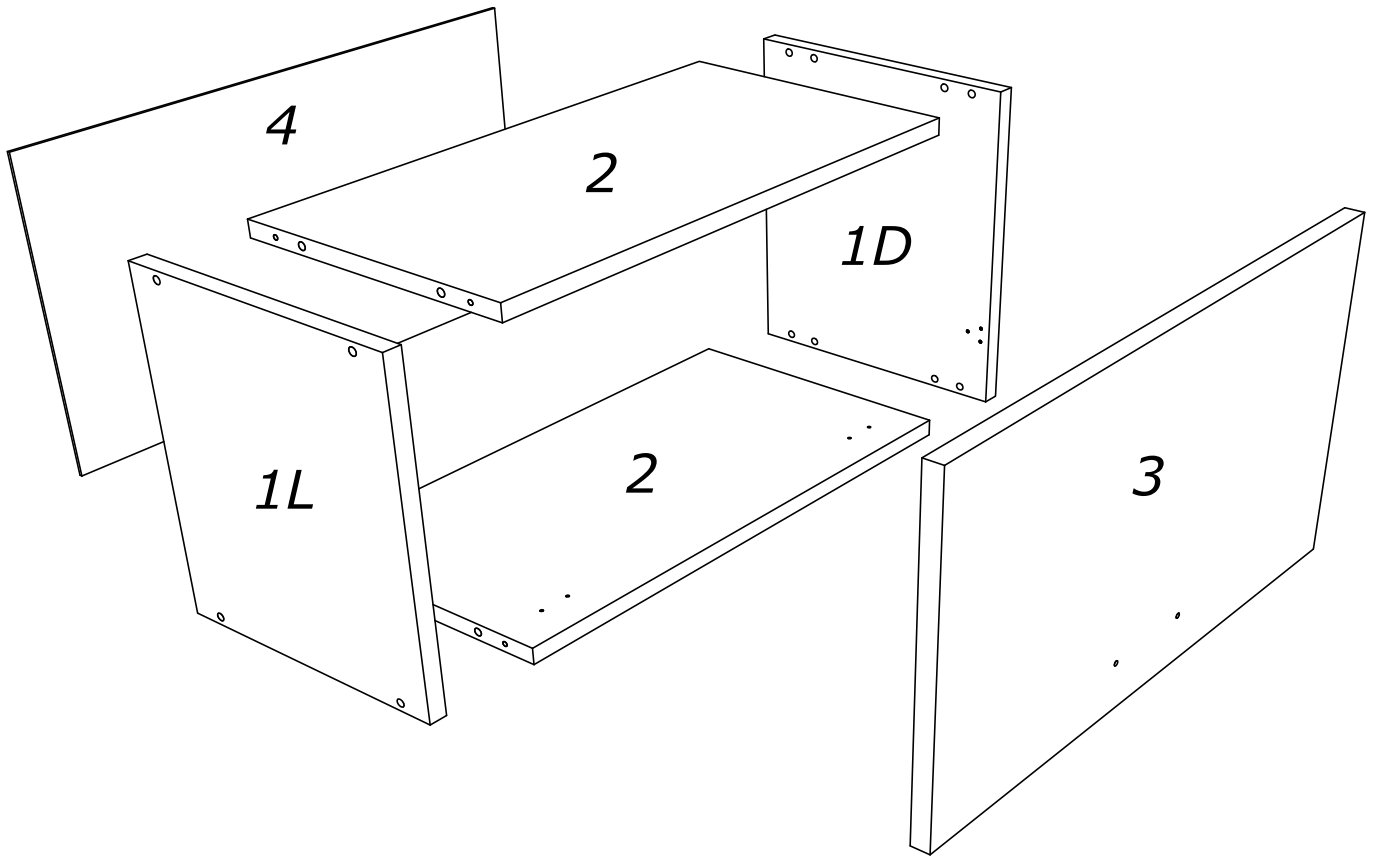
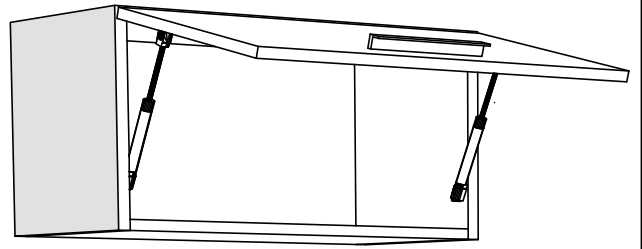

Senjak bb\*32250 Ivanjica\*Srbija

Tel:032 651 159\* Fax:032 651 060

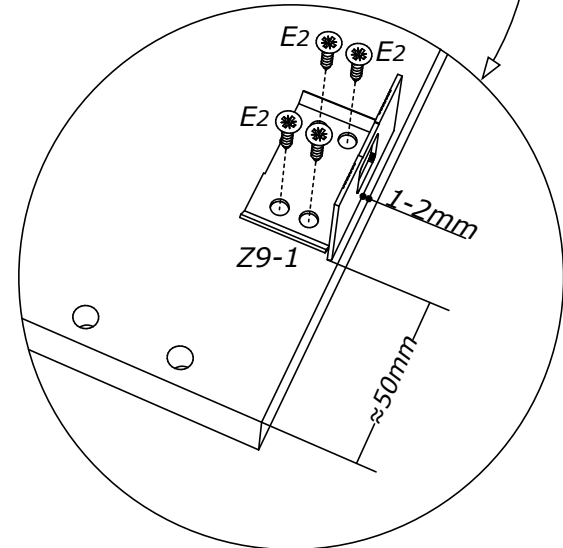
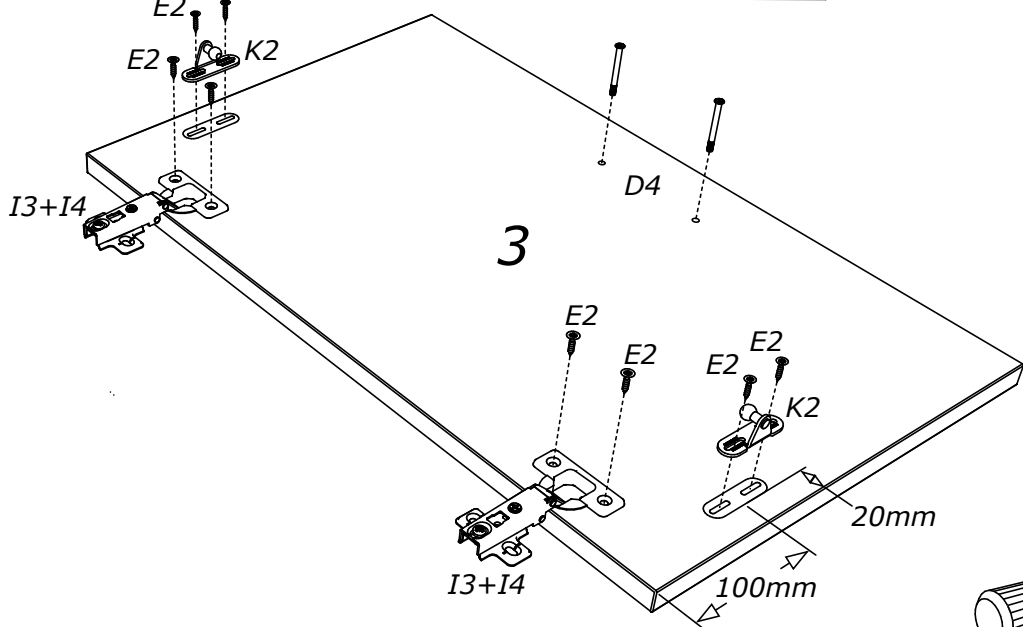
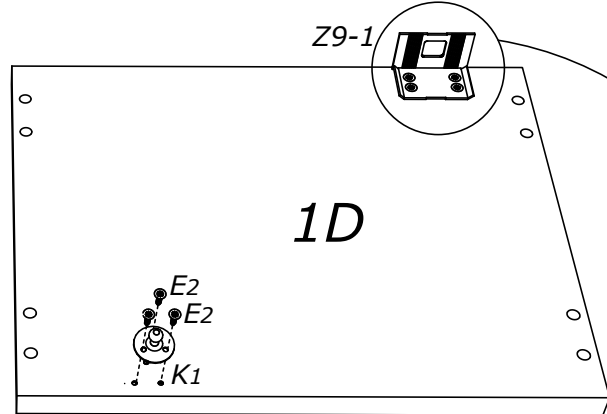
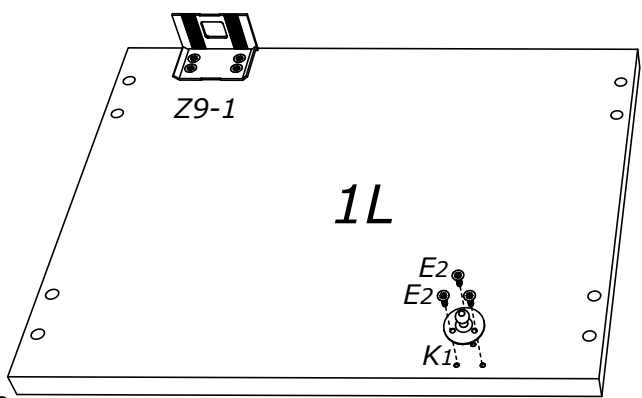
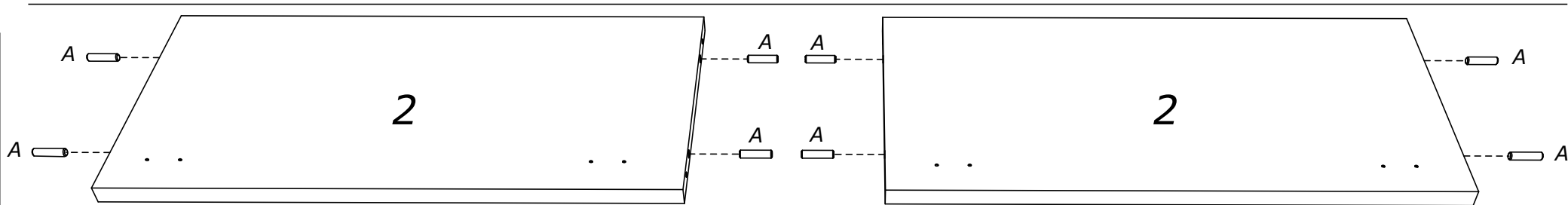
office@matis.rs\*veleprodaja@matis.rs\*www.matis.rs

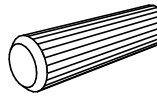

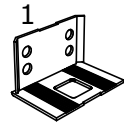

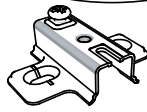
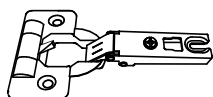
- A  

- E2  
  
4x16mm
- Z9  

- K1  

- I3  

- I4  

- K2  
